

**EZ-LOC® MECHANICAL BRACKET
FIXED TOP CLAMP WITH ADJUSTABLE FOOTPLATE
PARTS AND INSTRUCTION MANUAL**



Shown: Model QM-EZL-F

With the EZ-LOC Mechanical Bracket, simply return the SCBA to the bracket and with as little as one finger, press down on the top clamp to quickly and easily secure. There is no need to risk damage to hands and SCBAs by slamming, jamming, or shoving a cylinder back into place. The EZ-LOC is easy on the firefighters and easy on the SCBA.

NFPA 1901-09 compliant and third party tested to exceed the NFPA 9G standard. Fits most SCBAs with only minor adjustments.

Zico's patented ratchet design locks the SCBA over a range of engagement, so that even in a partially closed position there is never any doubt that the cylinder is secure.

Built with a PVC-coated top clamp to prevent damage to cylinders while in use and a steel backplate to provide a strong backbone. Both the backplate and the cast aluminum footplate are powder-coated to provide years of trouble-free service.

Donning the SCBA is fast and easy. The firefighter simply slips into the harness, pulls the release cable, and is ready to go.

WARNING: Bracket and SCBA harness are not to be used in place of a seat belt.

MODEL	DESCRIPTION	WT./@ IN LBS.
QM-EZL-F	EZ-LOC Bracket with fixed top clamp, adjustable footplate and universal pull release	12.8
QM-EZL-F-LR	EZ-LOC Bracket with fixed top clamp and adjustable footplate without a release	12.6

Parts Diagram - EZ-LOC Fixed Top Clamp - Adjustable Footplate

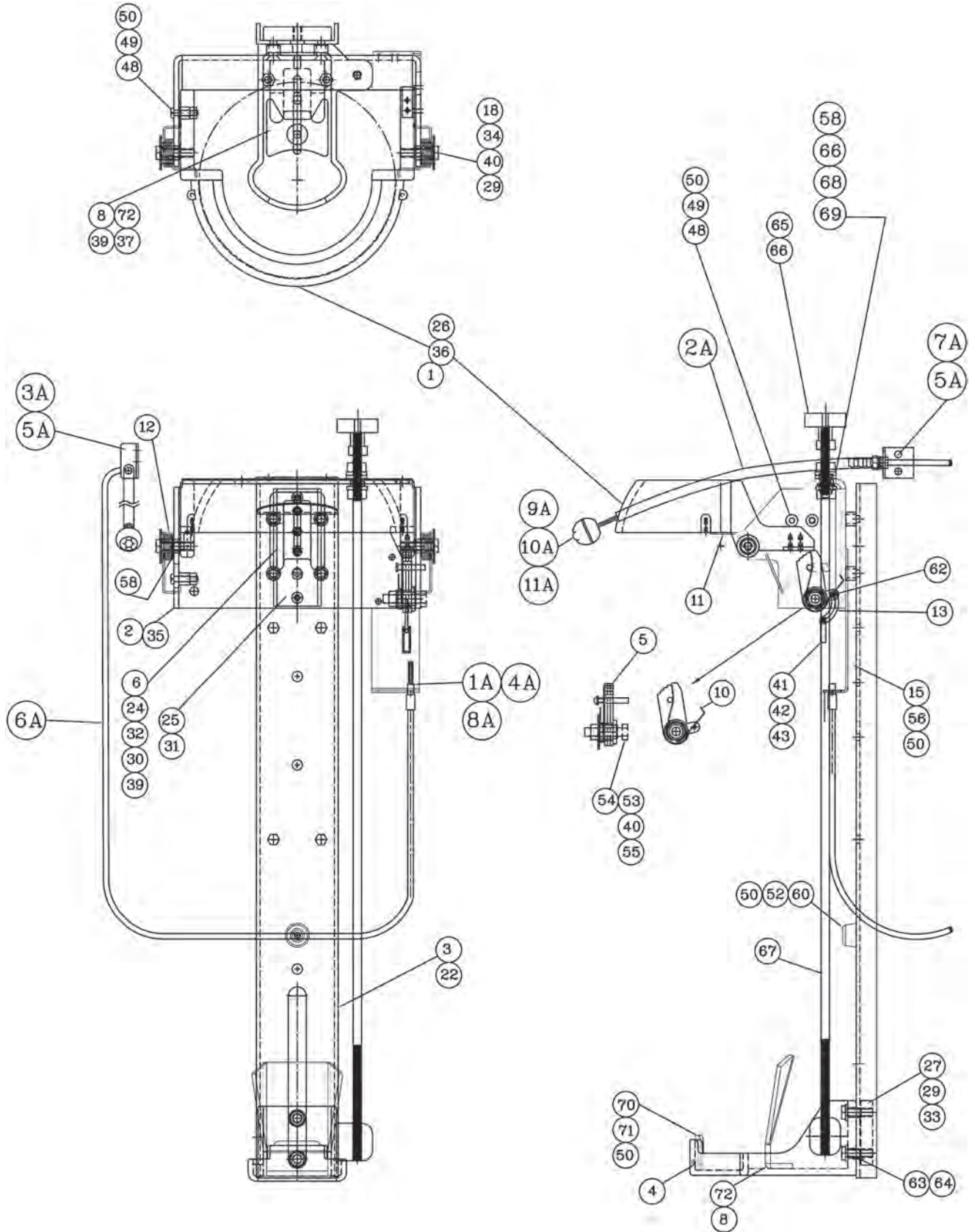

Parts Breakdown - EZ-LOC Fixed Top Clamp - Adjustable Footplate

ITEM NO.	PART NO.	DESCRIPTION	QTY.
1	1029-105-101	Top Clamp	1
2	1029-105-103	Upper Bracket Modified	1
3	1045-320-105	Backplate	1
4	1045-320-107	Footplate	1
5	1029-105-905	Serrated Latch Assembly	1
6	1045-320-111	Cyl. Locator/Bumper	1
8	1045-320-106	Footplate Guide	1
10	1029-105-109	Latch Spring	1
11	1026-005-107	Counter Spring, Top Clamp, LH	1
12	1026-005-109	Counter Spring, Top Clamp, RH	1
13	1029-105-115	Solenoid Link	1
15	1026-005-105	EZ-LOC Release Bracket	1
18	1045-320-131	Spacer, Top Clamp Pivot	2
22	1045-320-139	Spacer, 3/8 Sched 80 Alum., 675 OD x .423 ID x .550 LG	2
24	1045-320-143	Backup Plate, Bumper	1
25	1045-320-183	Spacer/Locator, Bumper	1
26	1029-105-125	Striker Plate	1
27	1029-105-127	Footplate Mounting Block	1
29	9014-203100	Lockwasher, 5/16ø Nom., Split	4
30	9014-202500	Lockwasher, 1/4ø Split	1
31	9010-162010	Screw, 10-32 x 5/8" Lg., FH 82°, SZP, Phil	2
32	9010-562516	Screw, 1/4-20 x 1" RD HD Torx, Bumper Mount	1
33	9018-103116	Screw, 5/16-18 x 1" HH, Gr 8	2
34	9015-103120	Screw, 5/16-18 x 1- 1/4 HH, Gr. 5	2
35	9010-462516	Screw, 1/4-20 x 1 FH, Torx	4
37	9015-172500	Nut, 1/4-20, Self Lock, GR 5	1

ITEM NO.	PART NO.	DESCRIPTION	QTY.
39	9014-182500	Washer, 1/4ø, GR8, 1/16 Thk., SAE	2
40	9014-163100	Bar Washer, 5/16 Nom. x 1 1/4 x 1/16 SZP	3
41	1045-320-161	Strap Fork	1
42	9160-201206	1/8 x 3/8 S/S FH Rivit	1
43	9112-401200	1/8 Cap Nut	1
48	1045-320-171	Spacer, Top Clamp Stop	2
49	9010-222014	Screw, 10-32 x 7/8" Lg., PH, SZP, Phil	2
50	9013-252000	Nut, 10-32, Hex, Self Loc	6
52	9010-222010	Screw, 10-32 x 5/8" Lg., PH, SZP, Phil	1
53	1029-105-137	Sleeve, Serrated Latch	1
54	9018-103124	Screw, 5/16-18 x 1 1/2" HH, Gr 8	1
55	9018-173100	Nut, 5/16-18, Hex, Self Loc, GR 8	1
56	9010-332012	Screw, 10-32 x 3/4" Lg., Skt. Hd., SZP Capscrew	2
58	3097-105-130	Washer, Plastic, 1/2 ID x 3/4 OD x .062	3
60	1090-000-150	Rubber Bumper (ACSR)	1
62	9040-101206	Spring Pin, 1/8 x 3/8 ZPS	1
63	1045-320-197	Sleeve, Spacer, Footplate	2
64	1045-320-199	Spacer, Footplate	2
65	1045-320-175	Knob, Footplate Adjustment	1
66	9015-113100	Nut, 5/16-18 Hex	3
67	1045-320-113	Adjustment Rod	1
68	1045-320-137	Spacer	1
69	9114-113100	Flatwasher, Plain, 5/16ø, SS	2
70	1027-110-109	MSA Extension	1
71	9010-352012	Screw, 10-32 x 3/4 BH Allen	2
72	9010-562520	1/4-20 x 1-1/4" Pan Hd Torx Mach. Screw, ZPS	1

UNIVERSAL PULL RELEASE

ITEM NO.	PART NO.	DESCRIPTION	QTY.
1A	1026-200-101	Release Cable Assembly (54 3/4")	1
2A	1027-105-131	Yellow Tubing 10"	1
3A	1010-175-131	Barbed Fitting	1
4A	1026-200-103	Spring	1
5A	1027-105-125	Pull Release Brkt., Release End	1
6A	1027-105-129	Conduit With Crimped Fitting	1
7A	9025-172006	Screw, 10-32 Hex Wsh Hd, Thread Frmg, ZPS	2
8A	1027-105-137	Push Nut (For 6MM Rod)	1
9A	1045-320-169	Pull Release Knob	1
10A	1045-320-185	Stop Sleeve	1
11A	9010-391603	Setscrew, #8-32 x 3/16 Flat Point	1

Parts Terminology - EZ-LOC Fixed Top Clamp - Adjustable Footplate

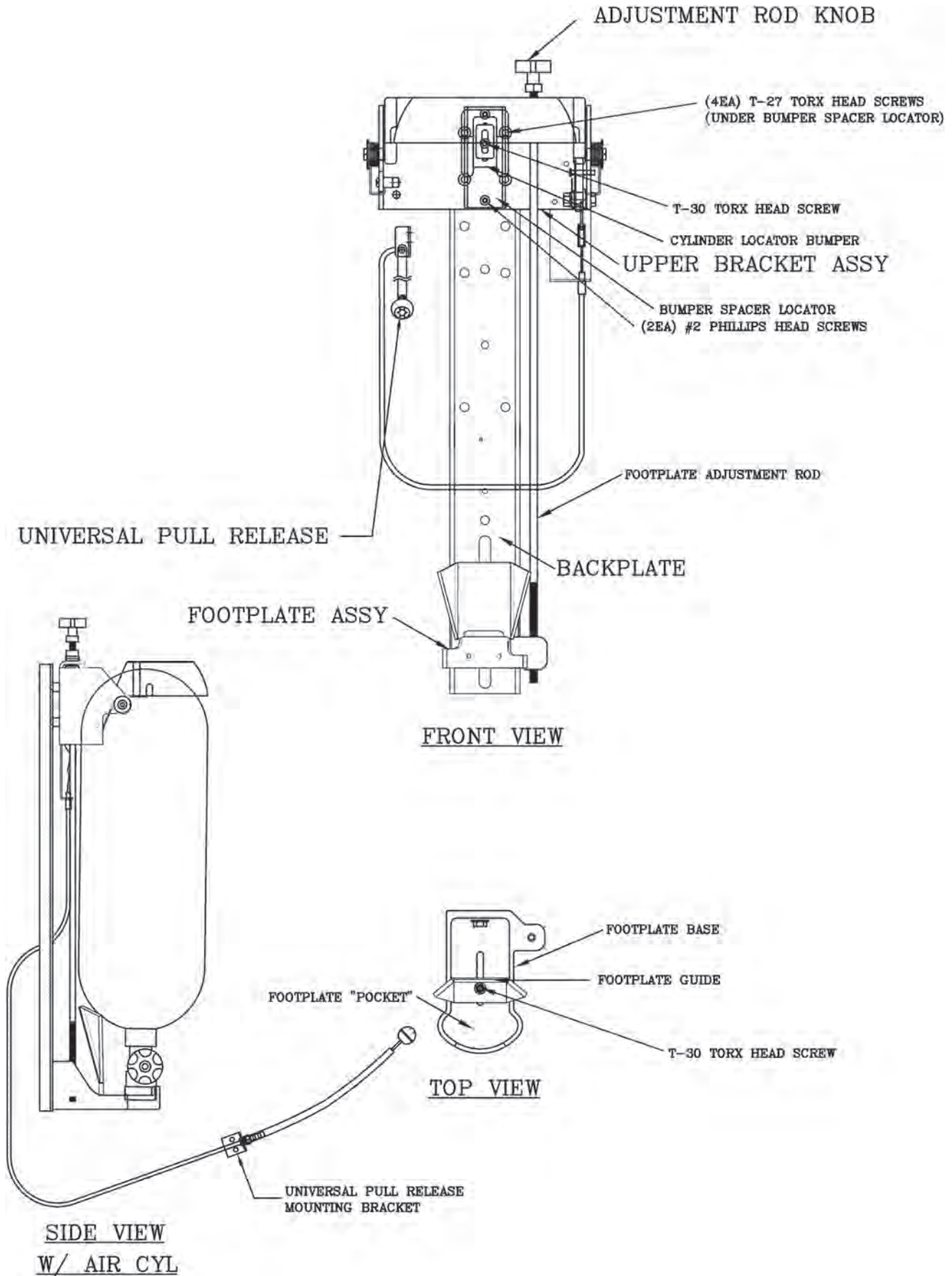

Set-Up Instructions - EZ-LOC Fixed Top Clamp - Adjustable Footplate

1. Loosen the T-30 torx head screw holding the Footplate Guide to the Footplate just enough so that the Footplate Guide can slide back and forth on the Footplate. If you are using an MSA cylinder, the MSA footplate extension may need to be installed (see page 14).
2. Place the bottom of your SCBA Air Cylinder Valve in the Footplate Assembly. While keeping the Air Cylinder Valve as far forward as it will go in the Footplate "pocket", slide the Footplate Guide so there is approximately 3/8" clearance between the Footplate Guide and the bottom of the Air Cylinder Valve (see Figure 1, below).



Figure 1

3. Remove the SCBA Air cylinder from the Footplate and re-tighten the T-30 torx head screw holding the Footplate Guide.
4. Determine the most accommodating position for your Upper Bracket Assembly using the information from the chart on pages 6-7 and the diagram on page 8. If your EZ-LOC was not pre-set for your specific SCBA prior to shipping, it will come standard in the "B" position. If your SCBA is currently in the correct position, skip to step 9.

SCBA Reference Chart

SCBA Brand, Model	AirCyl Type	Upper Bracket Location	Bumper Location	Bumper Position
Draeger Air Boss Evolution Plus PSS 100	30 Min 2216 PSI	A/B	1	S
Draeger Air Boss Evolution Plus PSS 100	30 Min 2216 PSI Alum Flat Top*	A	1	S
Draeger Air Boss Evolution Plus PSS 100	30 Min 4500 PSI	A/B	2	L
Draeger Air Boss Evolution Plus PSS 100	45 Min 4500 PSI	A/B	2	S
Draeger Air Boss Evolution Plus PSS 100	60 Min 4500 PSI	A	2	S
Draeger Air Boss Evolution	30 Min 2216 PSI	A/B	1	S
Draeger Air Boss Evolution	30 Min 2216 PSI Alum Flat Top*	A	1	S
Draeger Air Boss Evolution	30 Min 4500 PSI	A/B	2	L
Draeger Air Boss Evolution	45 Min 4500 PSI	A/B	2	S
Draeger Air Boss Evolution	60 Min 4500 PSI	A	2	S
Draeger PSS 7000	30 Min 2216 PSI	A/B	1	S
Draeger PSS 7000	30 Min 2216 PSI Alum Flat Top*	A	1	S
Draeger PSS 7000	30 Min 4500 PSI	A/B	2	L
Draeger PSS 7000	45 Min 4500 PSI	A/B	2	S
Draeger PSS 7000	60 Min 4500 PSI	A	2	S
Global Safety Pioneer	30 Min 4500 PSI	A/B	2	L
Global Safety Pioneer	45 Min 4500 PSI	A/B	2	S
Global Safety Pioneer	60 Min 4500 PSI	A	1	S
Interspiro Spiromatic S4	30 Min 4500 PSI	A/B	2	L
Interspiro Spiromatic S4	45 Min 4500 PSI	A	2	L
Interspiro Spiromatic S4	60 Min 4500 PSI	A	2	S
ISI Viking DXL	30 Min 4500 PSI	A	3	L
ISI Viking DXL	45 Min 4500 PSI	B	2	S
ISI Viking DXL	60 Min 4500 PSI	A	2	S
Avon-ISI Viking Z-7	30 Min 2216 PSI	B	2	S
Avon-ISI Viking Z-7	30 Min 4500 PSI	B	2	L
Avon-ISI Viking Z-7	45 Min 4500 PSI	A/B	2	L
Avon-ISI Viking Z-7	60 Min 4500 PSI	A	2	S
MSA Firehawk	30 Min 2216 PSI	A/B	2	S
MSA Firehawk	30 Min 2216 PSI Alum Flat Top*	A	1	S
MSA Firehawk	30 Min 3000 PSI	A/B	2	S
MSA Firehawk	30 Min 4500 PSI	A/B	2	L
MSA Firehawk	45 Min 4500 PSI	A/B	2	S
MSA Firehawk	45 Min 4500 PSI	A/B	2	S
MSA Firehawk	Low Profile			
MSA Firehawk	60 Min 4500 PSI	A	2	S

* Flat top cylinders require an additional Modified Locator Bumper, Model 1045-320-114 (see page 19).

SCBA Reference Chart

SCBA Brand, Model	AirCyl Type	Upper Bracket Location	Bumper Location	Bumper Position
MSA Firehawk M-7	30 Min 2216 PSI	A/B	2	S
MSA Firehawk M-7	30 Min 2216 PSI Alum Flat Top*	A	1	S
MSA Firehawk M-7	30 Min 3000 PSI	A/B	2	S
MSA Firehawk M-7	30 Min 4500 PSI	A/B	2	L
MSA Firehawk M-7	45 Min 4500 PSI	A/B	2	S
MSA Firehawk M-7	45 Min 4500 PSI Low Profile	A/B	2	S
MSA Firehawk M-7	60 Min 4500 PSI	A	2	S
MSA Stealth	30 Min 2216 PSI	A/B	2	S
MSA Stealth	30 Min 2216 PSI Alum Flat Top*	A	1	S
MSA Stealth	30 Min 3000 PSI	A/B	2	S
MSA Stealth	30 Min 4500 PSI	A/B	3	L
MSA Stealth	45 Min 4500 PSI	A/B	2	S
MSA Stealth	60 Min 4500 PSI	A	2	S
Scott AP-50	30 Min 2216 PSI	A	2	S
Scott AP-50	30 Min 2216 PSI Alum Flat Top*	A	1	S
Scott AP-50	30 Min 4500 PSI	A/B	3	L
Scott AP-50	45 Min 4500 PSI Low Profile	A	3	S
Scott AP-50	45 Min 4500 PSI	A/B	3	S
Scott AP-50	45 Min 5500 PSI	A/B	3	S
Scott AP-50	45 Min 5500 PSI w/o Prot Cover	A	2	L
Scott AP-50	45 Min 5500 PSI w/Prot Cover	A	2	S
Scott AP-50	60 Min 4500 PSI	A	2	S
Scott AP-50	75 Min 5500 PSI	A	2	S
Scott AP-75	30 Min 2216 PSI	A	2	S
Scott AP-75	30 Min 2216 PSI Alum Flat Top*	A	1	S
Scott AP-75	30 Min 4500 PSI	A/B	3	L
Scott AP-75	30 Min 5500 PSI†	A/B	3	L
Scott AP-75	45 Min 4500 PSI	A/B	3	S
Scott AP-75	45 Min 4500 PSI Low Profile	A	3	S
Scott AP-75	45 Min 5500 PSI	A/B	3	S
Scott AP-75	45 Min 5500 PSI w/o Prot. Cover	A	2	L
Scott AP-75	45 Min 5500 PSI w/Prot. Cover	A	2	S
Scott AP-75	60 Min 4500 PSI	A	2	S
Scott AP-75	75 Min 5500 PSI	A	2	S

* Flat top cylinders require an additional Modified Locator Bumper, Model 1045-320-114 (see page 19).

† 30 Min 5500 PSI air cylinders require an additional Bumper Spacer Kit, Model 1045-320-912 (see page 19).

SCBA Reference Chart

SCBA Brand, Model	AirCyl Type	Upper Bracket Location	Bumper Location	Bumper Position
Scott NXG2	30 Min 2216 PSI	A	2	S
Scott NXG2	30 Min 2216 PSI Alum Flat Top*	A	1	S
Scott NXG2	30 Min 4500 PSI	A/B	3	L
Scott NXG2	45 Min 4500 PSI	A/B	3	S
Scott NXG2	45 Min 4500 PSI Low Profile	A	3	S
Scott NXG2	45 Min 5500 PSI w/o Prot. Cover	A/B	3	S
Scott NXG2	45 Min 5500 PSI w/Prot. Cover	A	2	L
Scott NXG2	60 Min 4500 PSI	A	2	S
Scott NXG2	75 Min 5500 PSI	A	2	S
Scott NXG7	30 Min 2216 PSI	A	2	S
Scott NXG7	30 Min 2216 PSI Alum Flat Top*	A	1	S
Scott NXG7	30 Min 4500 PSI	A/B	3	L
Scott NXG7	30 Min 5500 PSI†	A/B	3	L
Scott NXG7	45 Min 4500 PSI Low Profile	A	3	S
Scott NXG7	45 Min 4500 PSI	A/B	3	S
Scott NXG7	45 Min 5500 PSI	A/B	3	S
Scott NXG7	w/o Prot. Cover			
Scott NXG7	45 Min 5500 PSI	A	2	L
Scott NXG7	w/Prot. Cover			
Scott NXG7	60 Min 4500 PSI	A	2	S
Scott NXG7	75 Min 5500 PSI	A	2	S
Survivair Panther	30 Min 2216 PSI	A/B	2	S
Survivair Panther	30 Min 4500 PSI	A/B	2	L
Survivair Panther	45 Min 4500 PSI Low Profile	A	2	S
Survivair Panther	45 Min 4500 PSI	B	2	L
Survivair Panther	60 Min 4500 PSI	A	2	S
Survivair Warrior	30 Min 2216 PSI	A/B	2	S
Survivair Warrior	30 Min 4500 PSI	A	2	L
Survivair Warrior	45 Min 4500 PSI Low Profile	A/B	2	S
Survivair Warrior	45 Min 4500 PSI	A/B	2	S
Survivair Warrior	60 Min 4500 PSI	A	2	S

* Flat top cylinders require an additional Modified Locator Bumper, Model 1045-320-114 (see page 19).

† 30 Min 5500 PSI air cylinders require an additional Bumper Spacer Kit, Model 1045-320-912 (see page 19).

SCBA Reference Diagram

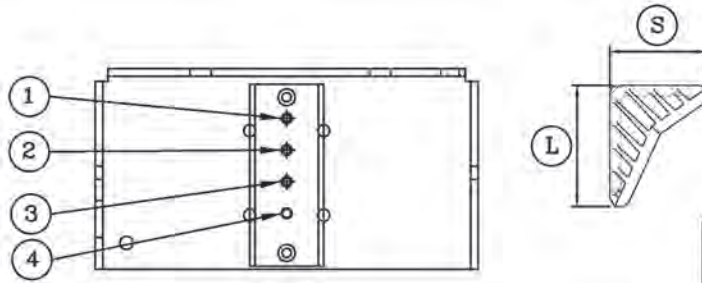

IN CASE SMALL DIAMETER AIR CYL DOES NOT REACH BUMPER.
TURN SPACER BLOCK 180 DEG.

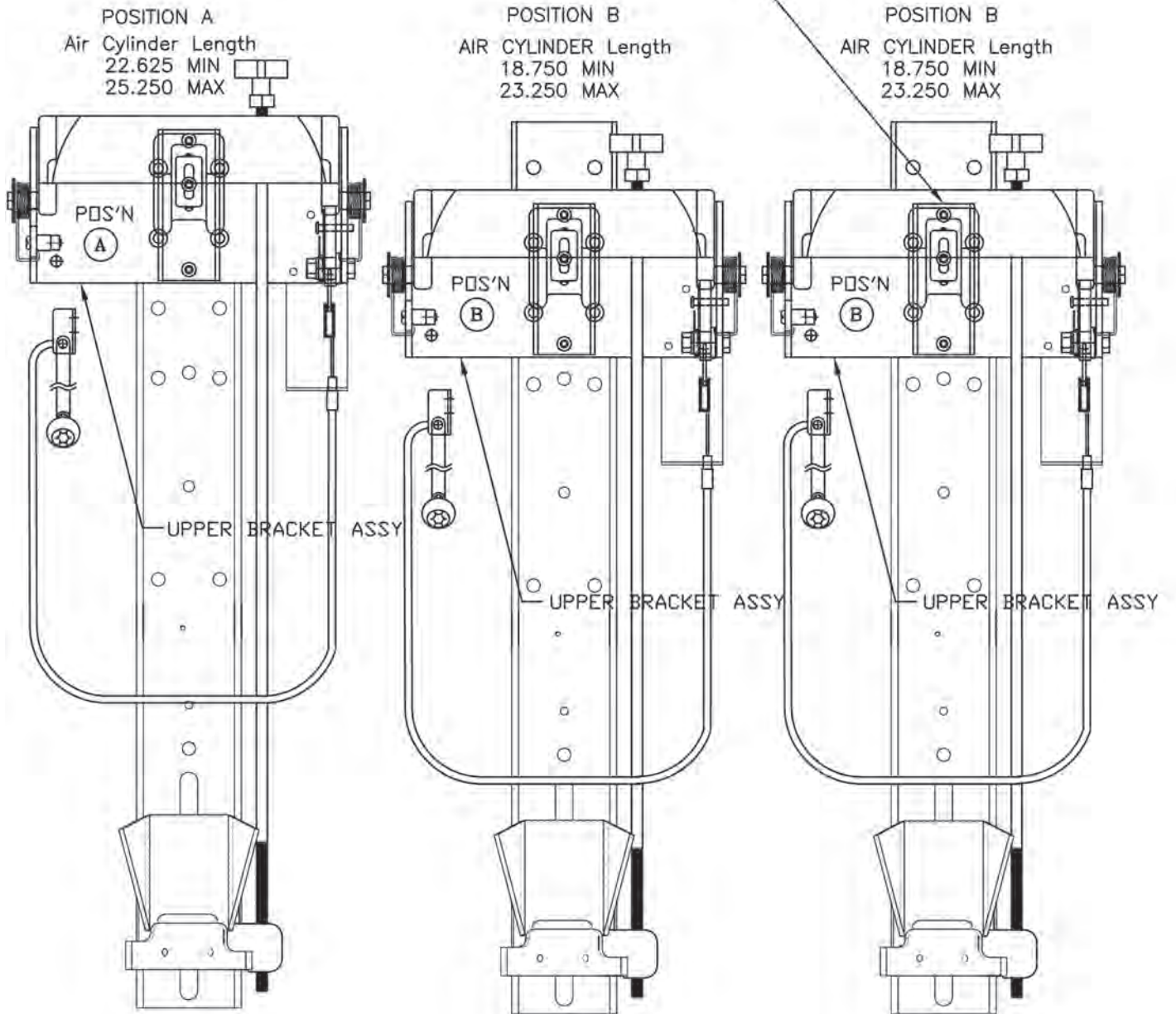

- 1) AIR CYLINDER SHOULD BE FITTED TO BRACKET AS PER INSTRUCTION.
- 2) MOUNT BACK PLATE TO SEAT SO FOOT PLATE IS LEVEL OR CLOSE AS POSSIBLE TO TOP OF SEAT CUSHION.

5. If you need to adjust the Upper Bracket Assembly to a different position, remove the T-30 torx head screw holding the Cylinder Locator Bumper (*see Figure 2, below*) and set the Cylinder Locator Bumper aside. Remove the (2) #2 Phillips head screws holding the Bumper Spacer Locator (*see Figure 3, below*), and set the Bumper Spacer Locator aside.



Figure 2

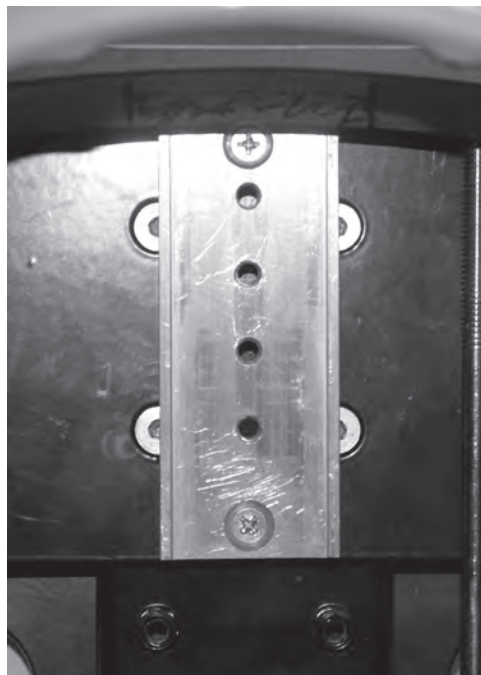

Figure 3

6. Remove the (4) T-27 torx head screws that are holding the Upper Bracket Assembly in place. Be sure not to let the weight of the Upper Bracket hang on the Adjustment Rod before reattaching.
7. Reattach the Upper Bracket Assembly in the desired position using the (4) T-27 torx head screws.
8. If using this bracket with a 30 min. 5500 PSI air cylinder, refer to page 19 now. Otherwise, reattach the Bumper Spacer Locator to the Upper Bracket Assembly with the (2) #2 Phillips head screws.
9. Referring again to the SCBA Reference chart on pages 6-7 and the diagram on page 8, determine the optimal bumper location for the Cylinder Locator Bumper (Note: If using this bracket with a flat-top air cylinder, the standard Cylinder Locator Bumper must be replaced with a modified version, see page 19). Reattach the Cylinder Locator Bumper by inserting the T-30 torx head screw into the appropriate bumper location hole in the Bumper Spacer Locator, leaving the T-30 torx head screw loose enough to allow the Cylinder Locator Bumper to slide up and down. Temporarily slide the Cylinder Locator Bumper as far up as it will go.
10. Measure the overall length of your desired air cylinder from bottom of the air cylinder valve to top of the air cylinder (*see Figure 4, below*). Add 1/2" to this measurement.

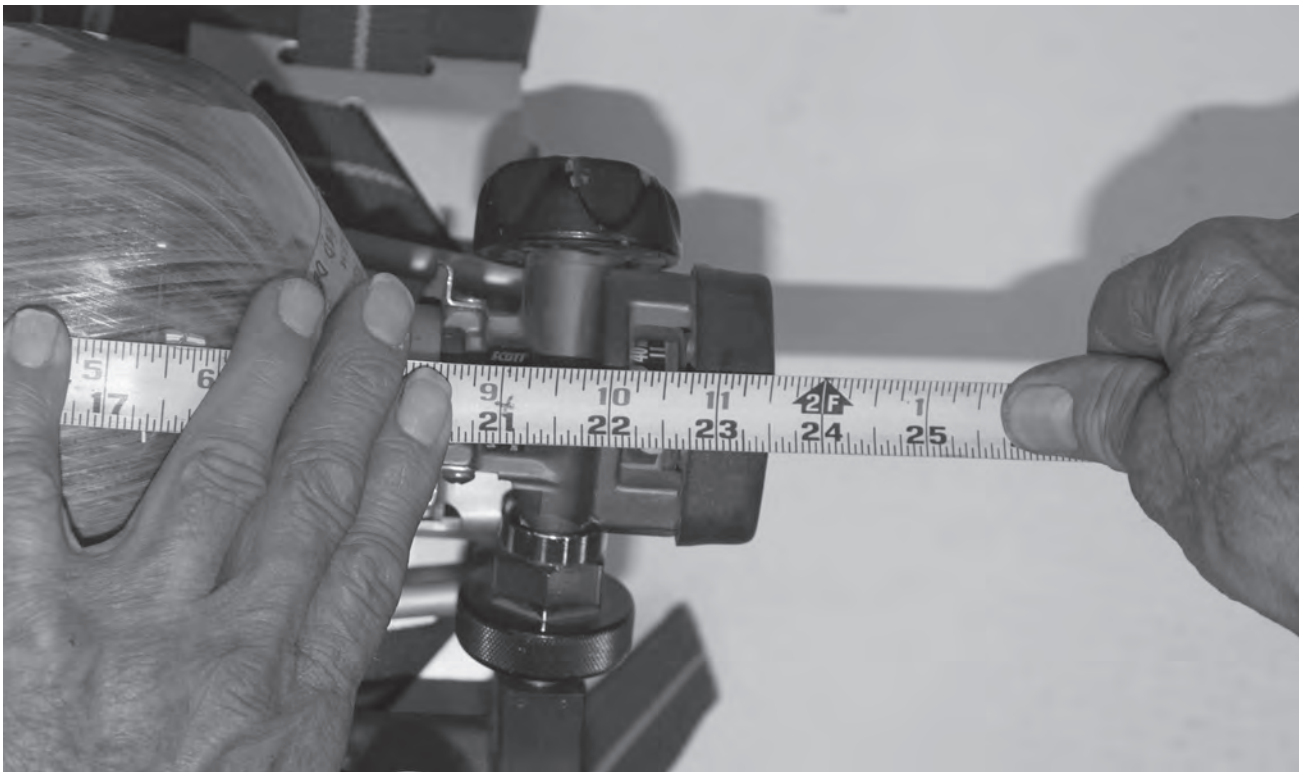

Figure 4

11. Measure the distance from the inside bottom of the Footplate to the inside top of the closed Top Clamp (*see Figure 5, page 11*). This distance should equal your overall length of the air cylinder plus 1/2". Use the Adjustment Rod Knob to turn the Footplate Adjustment Rod and achieve this measurement.

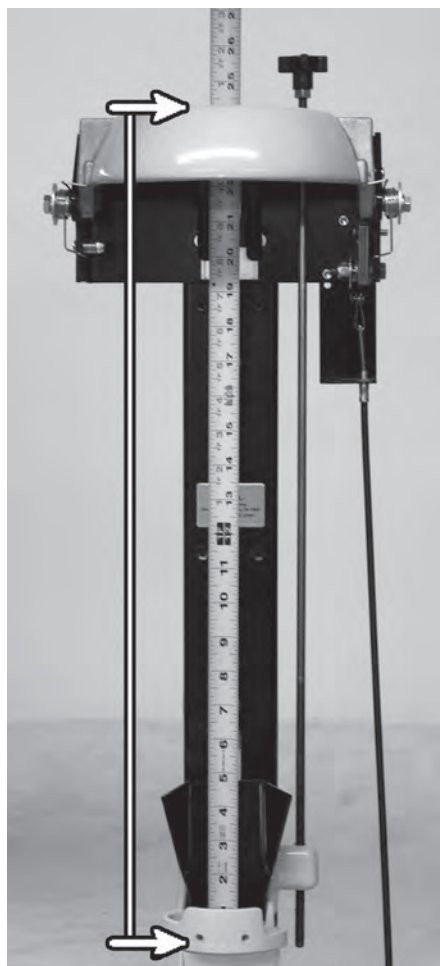

Figure 5

12. Press rearward on the Serrated Latch Stop Pin to open the Top Clamp. Place the air cylinder valve in the Footplate and move the SCBA into the bracket, closing the Top Clamp as the top of the air cylinder passes the front of the Top Clamp (*see Figure 6, below*).



Figure 6

13. The Top Clamp should be engaging the SCBA as much as possible without wedging between the air cylinder and the SCBA harness frame (*see Figure 7, below*).



WRONG - Catches Pack



WRONG - Too High on Bottle



CORRECT

Figure 7

14. With the SCBA in the stowed position, slide the Cylinder Locator Bumper up or down until it touches the air cylinder and keeps it held toward the front of the Top Clamp. Leave a slight amount of clearance (up to 1/16") between the top of the air cylinder and the Cylinder Locator Bumper. When positioned correctly, remove the air cylinder and tighten the T-30 torx head screw on the Cylinder Locator Bumper.
15. If the air cylinder cannot be held against the front of the Top Clamp by the Cylinder Locator Bumper, it may be necessary to change the location of the T-30 torx head screw holding the Cylinder Locator Bumper to a different bumper location (1, 2, 3 or 4) in order to get the correct fit described in step 16.
16. The SCBA should be held firmly in place. If it is not, repeat steps 9-15 and fine-tune until a satisfactory final adjustment is achieved.
17. With the Top Clamp in the closed position, check that the Serrated Latch Assembly is fully engaged (*see Figure 8, below*).

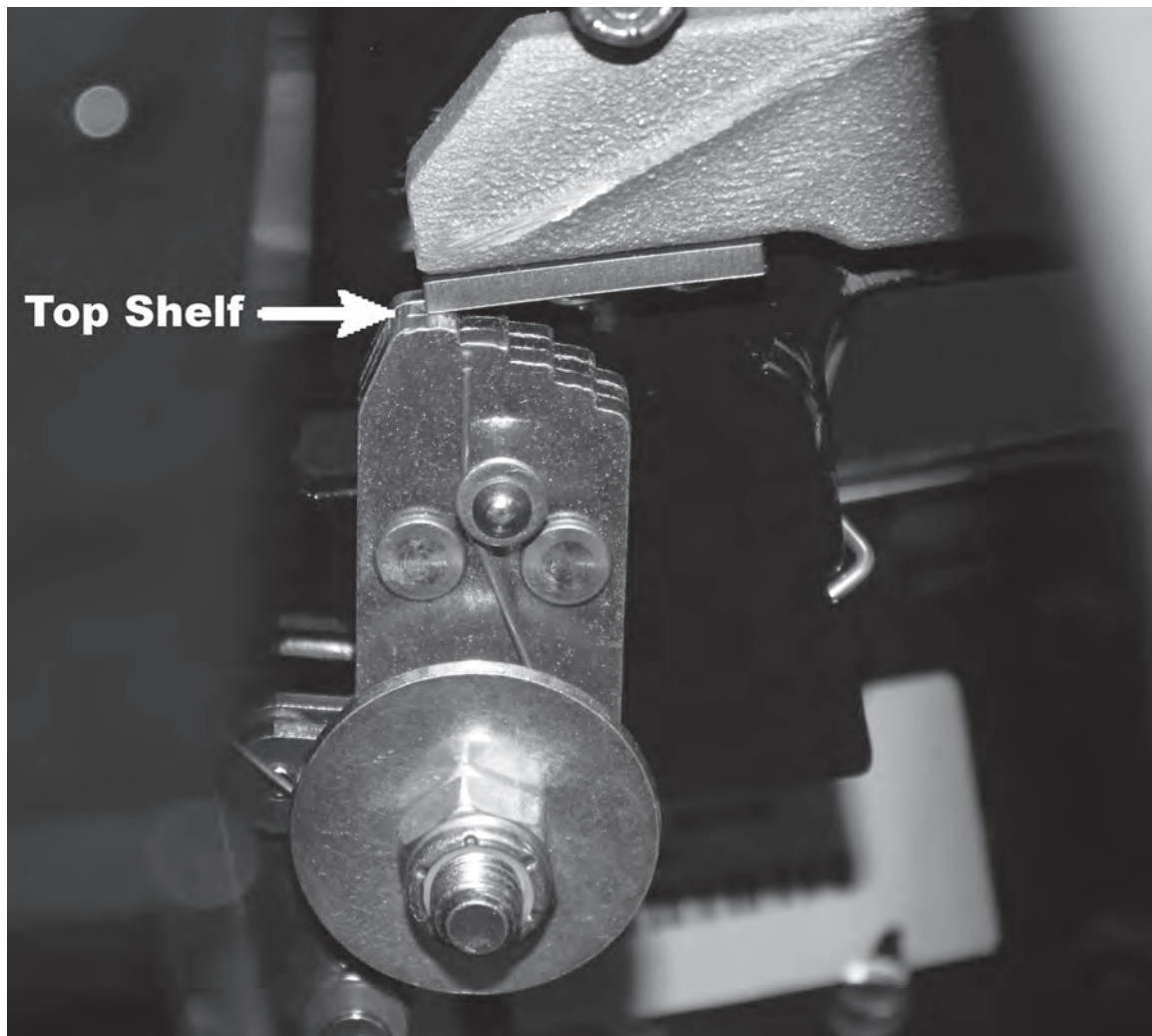

Figure 8

18. Check that locking and unlocking functions are working properly.

MSA SCBA Warning

If using the EZ-LOC with an MSA SCBA cylinder, you must read this important safety information:

TO SAFELY SECURE YOUR MSA SCBA

If your MSA SCBA cylinder uses a gauge guard with the approximate dimensions shown in Ref. A, you must use the included adapter plate as shown in Ref. B, secured to the inside of the Footplate as shown.

If your MSA SCBA has a smaller gauge guard, this adapter should not be used. Damage may result when using the adapter with a smaller gauge guard.

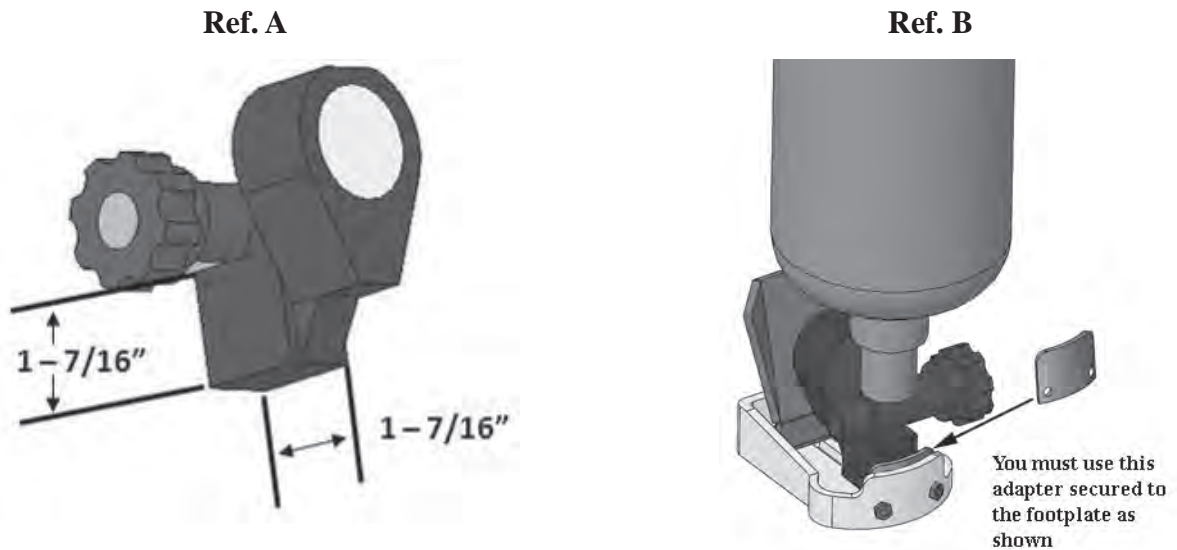

If your MSA SCBA is a Model G1, you must use the included Footplate Riser as shown in Ref. C, secured to the Footplate with double-sided tape (included). The adapter plate should not be used.

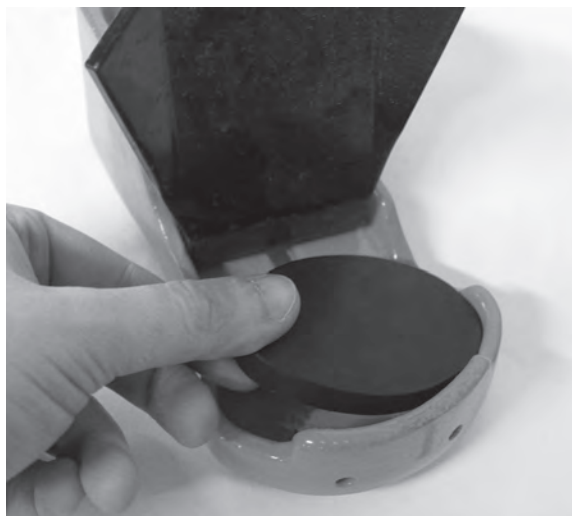

Ref. C

Mounting Requirements - EZ-LOC Fixed Top Clamp - Adjustable Footplate

- Minimum of (2) mounting points at least 10" apart using 5/16" O.D. screws.
- Spacer required between EZ-LOC Backplate and mounting surface (provided).
- Mounting surface must be able to withstand a pull-out force of 450 lbs.

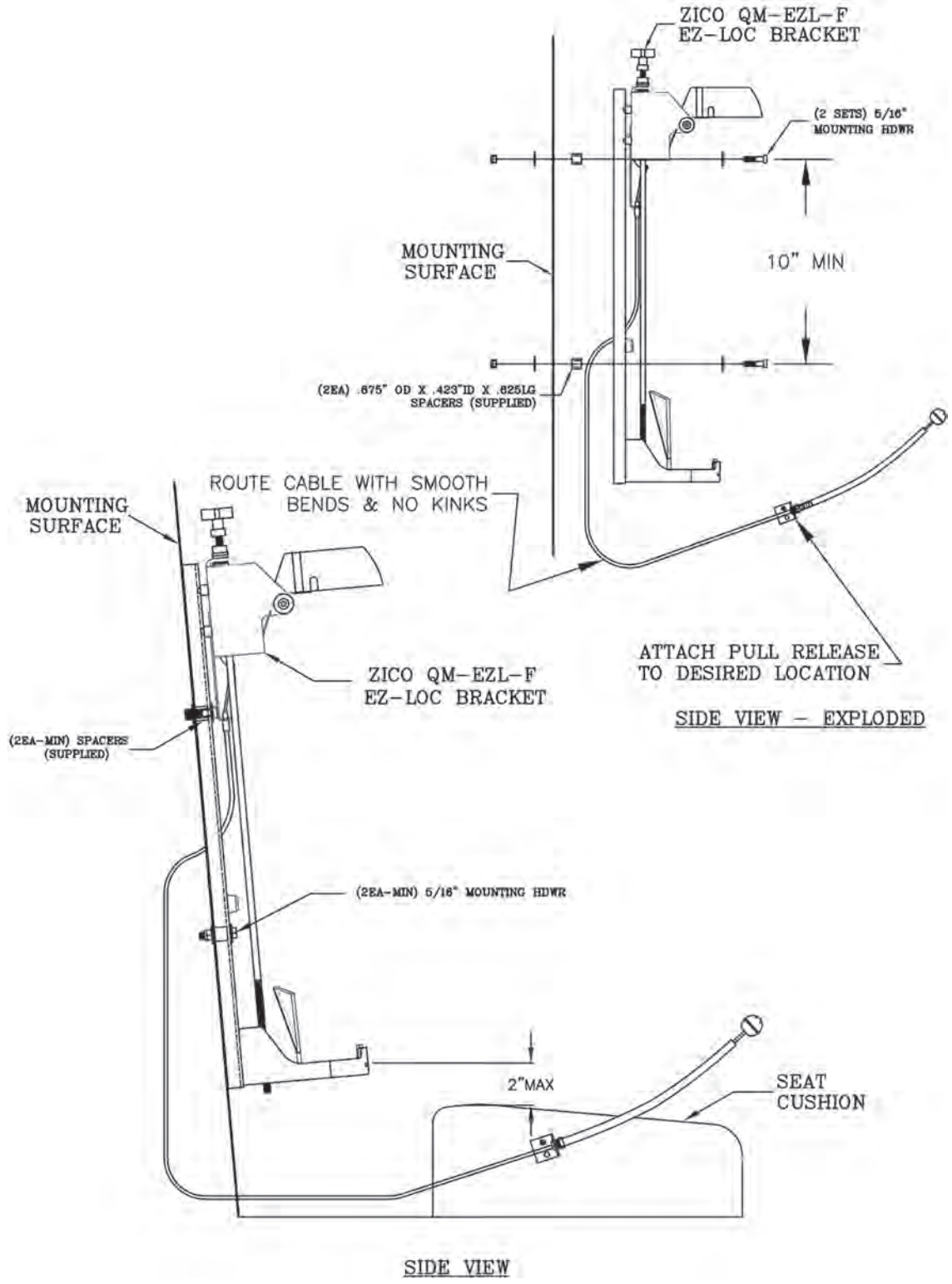

Mounting Instructions - Universal Pull Release

1. Position the Pull Release Bracket, complete with yellow tube and release cable, in the desired location against the Seat Frame.
2. Using a #19 drill bit (.166), drill two (2) holes in the Seat Frame. Thicker Seat Frames may require a larger bit size, #18 (.169).
3. Attach the Pull Release Bracket to the seat frame using two (2) 10-32 x 3/8" thread forming screws. Be sure to carefully run the cable and conduit around the seat and bracket without causing kinks in the cable or interference with the bracket's functions.

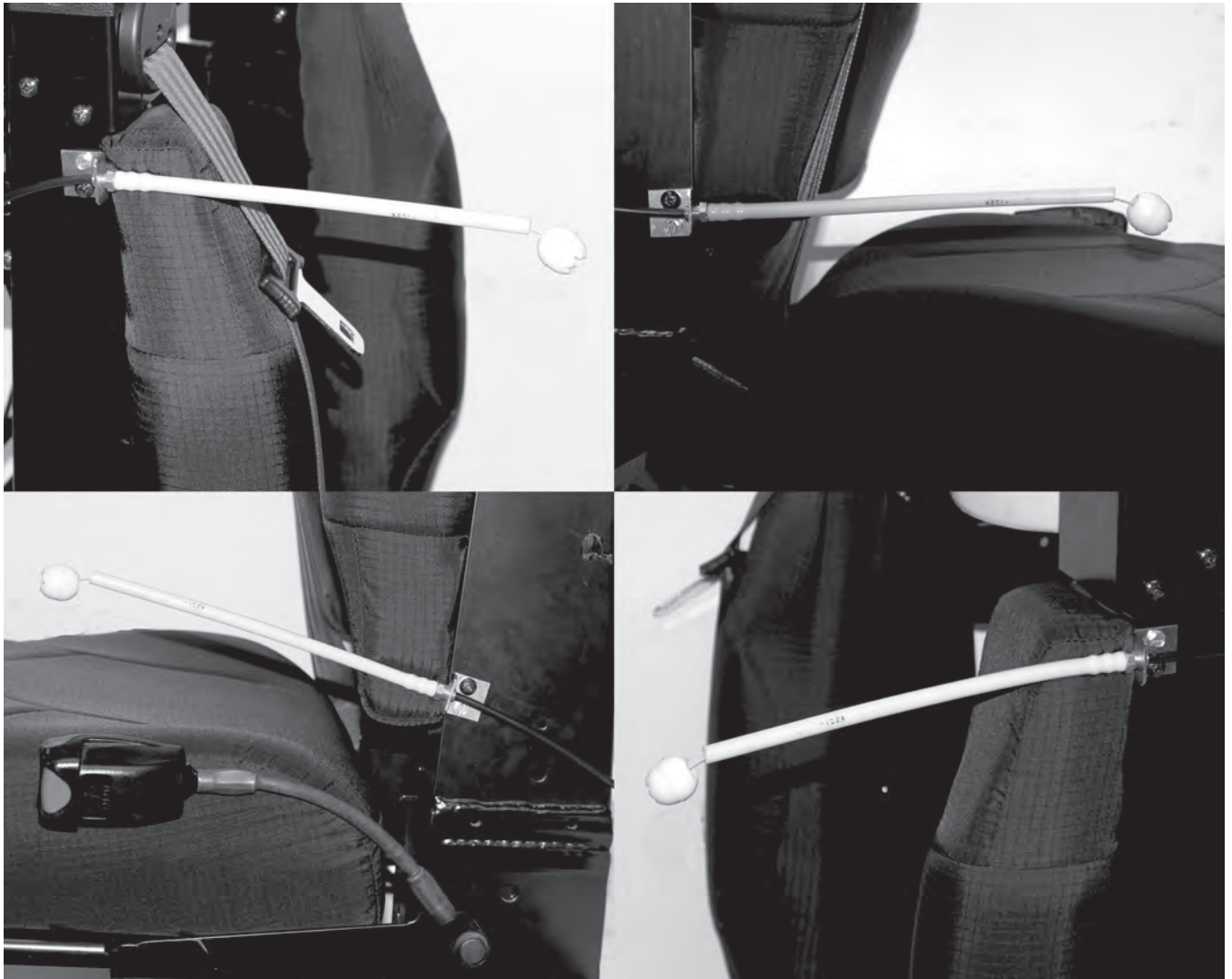

Examples of Possible Mounting Locations

Operating Instructions - EZ-LOC Fixed Top Clamp - Adjustable Footplate

These instructions should only be used after the EZ-LOC has been properly adjusted for the SCBA that is being used.

1. Place the valve of the SCBA in the Footplate. If the valve does not sit properly in the Footplate, the bracket will not lock as safely as possible.



2. Place the air cylinder against the Cylinder Locator Bumper and gently pull down the Top Clamp. When the Top Clamp locks, the bottle is secure. Check that the Striker Plate is resting on the top shelf of the Serrated Latch Assembly for maximum security.

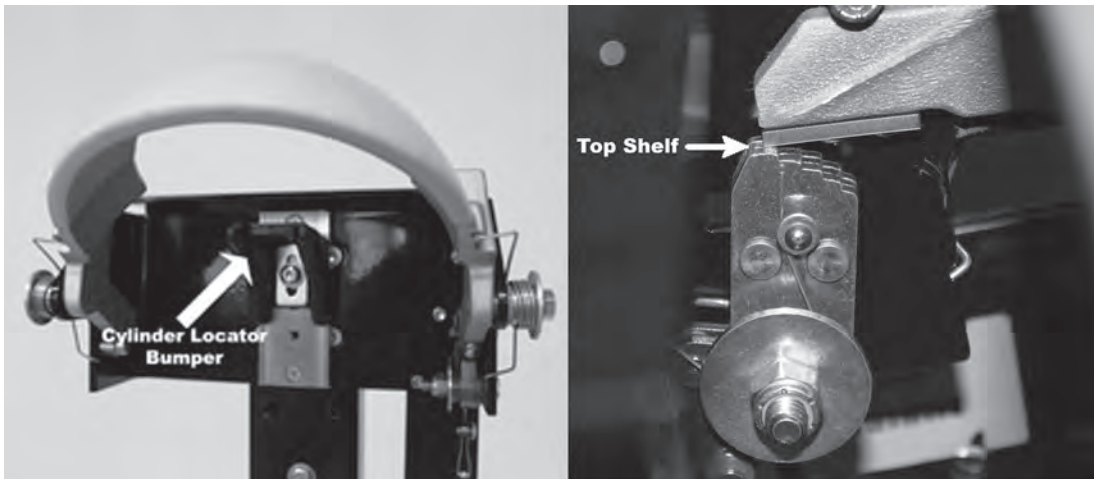

Locator Bumper Spacer Kit, Model 1045-320-912

For use with 30 min. 5500 PSI air cylinders.

Stacks between standard Locator Bumper Spacer and backplate to better accommodate the 5.5 cylinder's thinner shape and achieve maximum locking efficiency.

Note: 45 min. and larger 5.5 cylinders do not require this kit.



Spacer Installation Instructions:

1. Stack the original spacer on top of your new kit spacer (see left).
2. Set these spacers, together, against the Upper Bracket assembly of your SCBA, positioned for your 5.5 cylinder. Secure using the longer Phillips head screws included with this kit.
3. Continue with Step 9 of SCBA bracket adjustments.

Modified Locator Bumper for Flat-Top Cylinders, Model 1045-320-112

For use with flat-top cylinders. Replaces Standard Locator Bumper component to better accommodate the flat-top cylinder shape and achieve maximum locking efficiency.

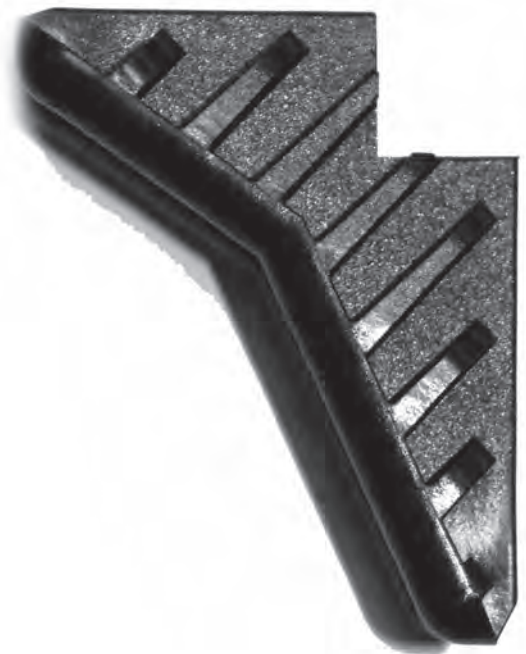



Ziamatic Corp.

10 West College Avenue, P.O. Box 337, Yardley, PA 19067-0587 • (215) 493-3618 • FAX: (215) 493-1401

www.ziamatic.com

TOLL FREE: 800-711-3473

*ZICO is a registered trademark for fire, safety and marine products made by Ziamatic Corp.

Copyright Ziamatic Corp. 1-17