

ZICO®

1026PM4

CENTER PULL RELEASE IN 911 SEAT MANUAL FOR THE EZ-LOC® MECHANICAL BRACKET



The center pull release kit allows the SCBA bracket to be released by pulling a "T" handle located on the front of the seat. The kit puts the release in an accessible location where it is not in the way of the SCBA pack straps or the seat belt. It includes all of the parts needed for setup.



Model QM-EZL-CPR is made for the EZ-LOC SCBA bracket mounted in a 911 Series seat. For additional models and other bracket/seat combinations please contact us at 1-800-711-FIRE.

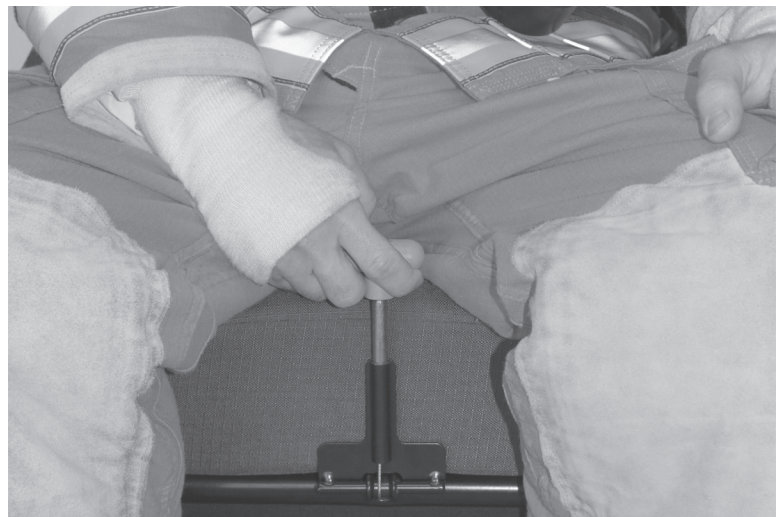

FOOT ADJUSTMENT
OPTIONAL

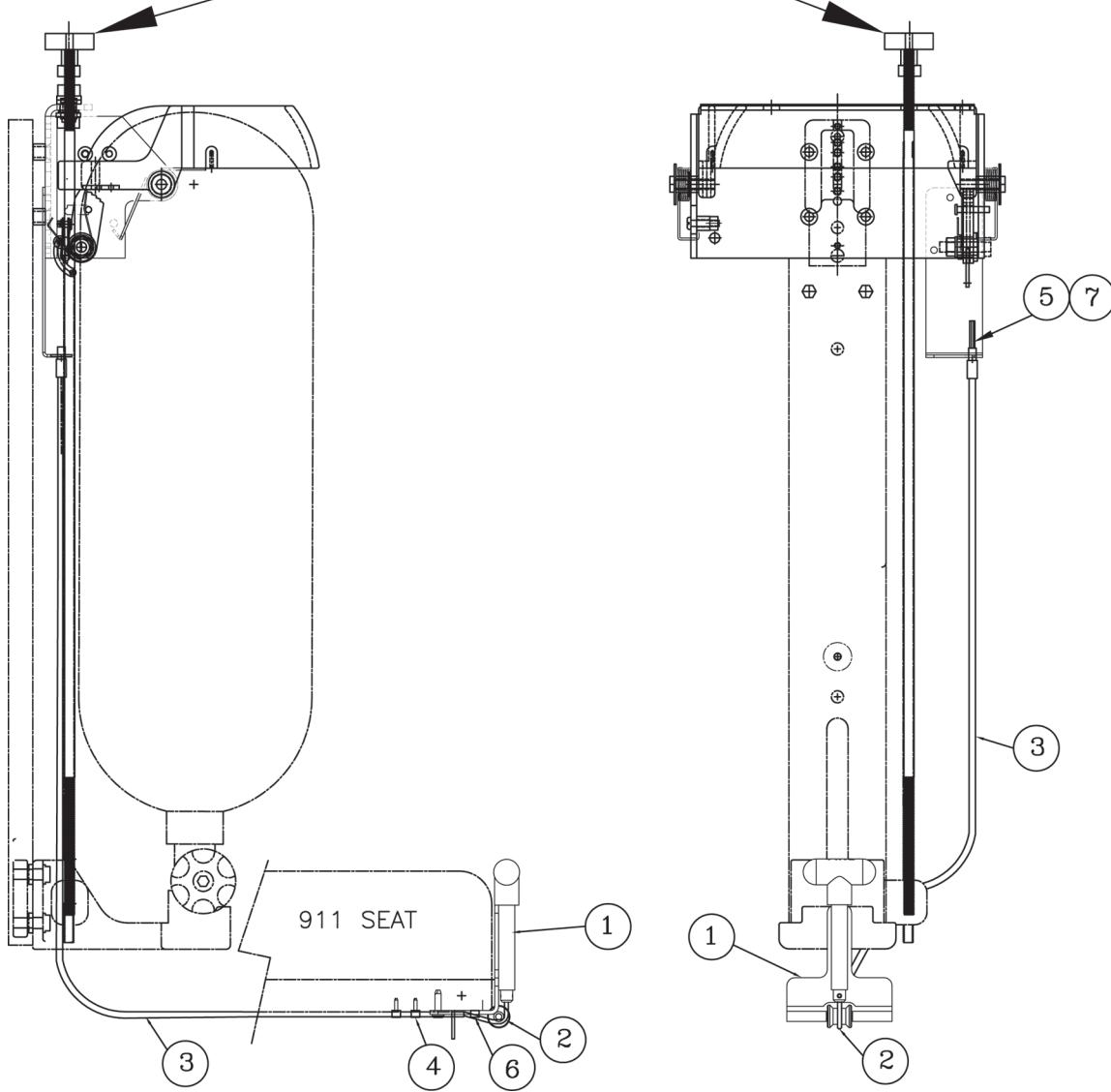

ITEM NO.	PART NO.	DESCRIPTION	QTY.
1	1010-065-125	911 Center Pull Release Assembly	1
2	1026-210-101	Pull Release Cable Assembly 51-1/2"	1
3	1026-210-995	Conduit Assembly 47"	1
4	9085-002012	#10 x 3/4" Phillips Pan Sht Mtl Screw	2
5	1027-105-137	Push Nut (For 6MM Rod)	2
6	1045-505-102	Adhes. Back Polyurethane Bumper	4
7	1026-200-103	Lee Spring (LC026B14M)	1

Center Pull Release Installation Instructions for 911 Series Seats

Before installing the Center Pull Release kit, make sure that the EZ-LOC is fully adjusted for the SCBA being used. The EZ-LOC should be mounted in the seat and fully operational.

Important: If you are converting your EZ-LOC from a Universal Pull Release to a Center Pull Release, begin at Step 1. If you are installing the Center Pull Release on a new EZ-LOC with no release, skip to Step 8.

1. Starting with the yellow ball on your Universal Pull Release, push the stop sleeve out of the yellow ball and loosen the set screw. Remove the stop sleeve and yellow ball.

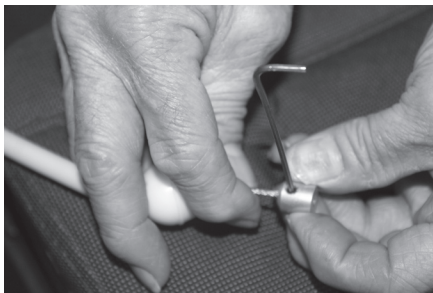
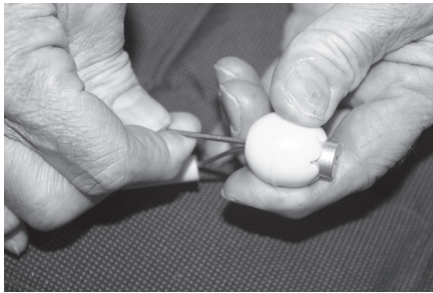

2. Remove the bracket holding the yellow pull release stalk (10" yellow tube) from your seat.

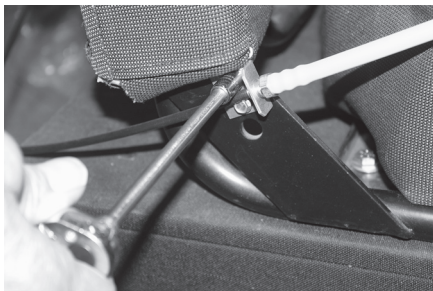

3. Using vise grips and a pry tool, carefully remove the push nut from the black mounting bracket that secures the black conduit assembly.



4. Remove the conduit assembly and slide the cable assembly out through the top of the strap fork. The lee spring should now be loose.

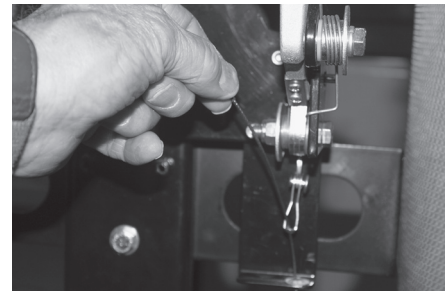

5. Now that all of the Universal Pull Release components are removed, begin your Center Pull Release installation by attaching your new conduit assembly 47" (Item 3) to the mounting bracket using a 6mm push nut (an extra push nut, Item 5, is provided in the event the first is damaged during installation).

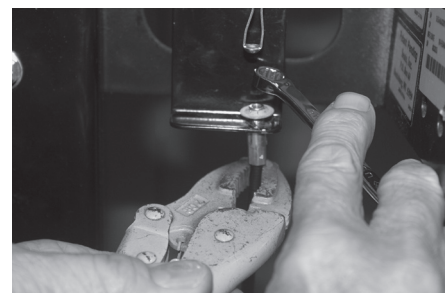

Center Pull Release Installation Instructions Continued

6. Attach your new cable (*Item 2*) through the strap fork. Slide your new lee spring (*Item 7*) onto the cable.



7. Slide the cable assembly (*Item 2*) through the conduit (*Item 3*).
8. Remove the seat cushion from the seat and place it in an easily accessible location.
9. On the bottom of the seat cushion, locate the black bracket and check to see if a 1/4" hole has been drilled at the lowest spot on the surface of the center point. If not, drill a hole as shown below.

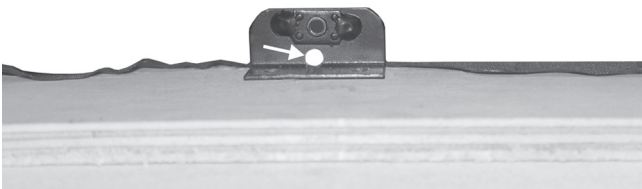

10. Feed the cable end of the cable assembly from the bracket location through the seat in a way that it will not be pinched or kinked when the cushion is in place. Then feed the cable assembly through the hole drilled in the previous step until the front cable bracket touches the black bracket. Once in place, use (2) #10 x 3/4" wood screws (*Item 4*) to secure it.

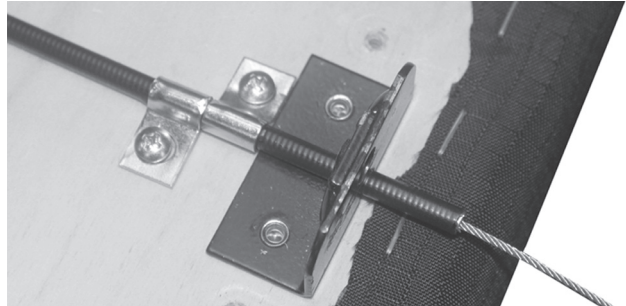

11. Hold the "T" handle and mounting bracket (*Item 1*) to the front of the seat so that it is flush on the front of the seat. Once in the proper position secure it using (2) #10 wood screws that are included in the bag with *Item 1*.

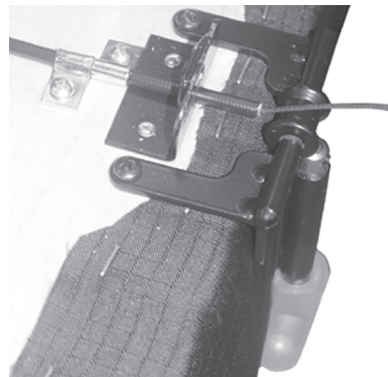

Center Pull Release Installation Instructions Continued

12. Attach (2) adhesive bumpers (*Item 6*) to the seat frame as shown in the picture.

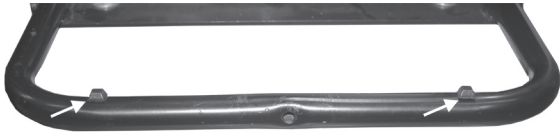

13. Re-attach the seat cushion to the frame and confirm that the cable and conduit is not being pinched or kinked by the cushion or attaching screw.
14. Feed the cable under the roller and towards the bottom of the "T" handle and pull the upper clamp on the EZ-LOC down. Confirm serrated latch assembly is fully engaged.



15. Insert the cable into the bottom of the "T" handle shaft. Make sure the "T" handle is in the down position then tighten the (2) 5/64" hex set screws. (There is one on the front and one on the back. The handle will need to be rotated 180° to reach the second screw.)

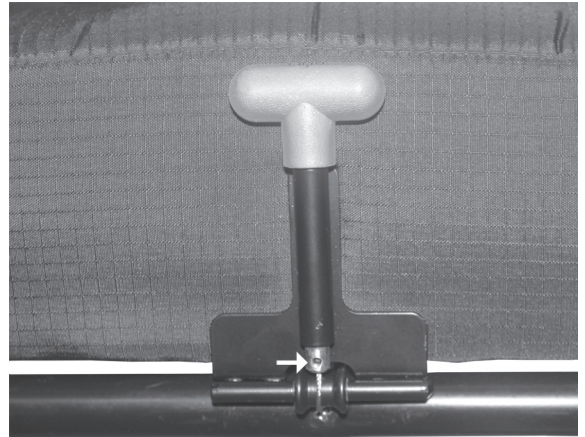

16. The center pull release should now be installed properly. Check to make sure that it releases the EZ-LOC properly and returns to the locked, fully-engaged position smoothly.



Ziamatic Corp.

10 West College Avenue, P.O. Box 337, Yardley, PA 19067-0587 • (215) 493-3618 • FAX: (215) 493-1401

*ZICO is a registered trademark for fire, safety and marine products made by Ziamatic Corp.

www.ziamatic.com

TOLL FREE: 800-711-3473

Copyright Ziamatic Corp. 3-11