

ZICO®

1026PM5

REV. 7-6-17

**CENTER PULL RELEASE IN BOSTROM 450 TANKER SEAT
FOR THE EZ-LOC® MECHANICAL BRACKET
MODEL QM-EZL-CPR-TS**

The center pull release kit allows the SCBA bracket to be released by pulling a "T" handle located on the front of the seat. The kit puts the release in an accessible location where it is not in the way of the SCBA pack straps or the seat belt. It includes all of the parts needed for setup.

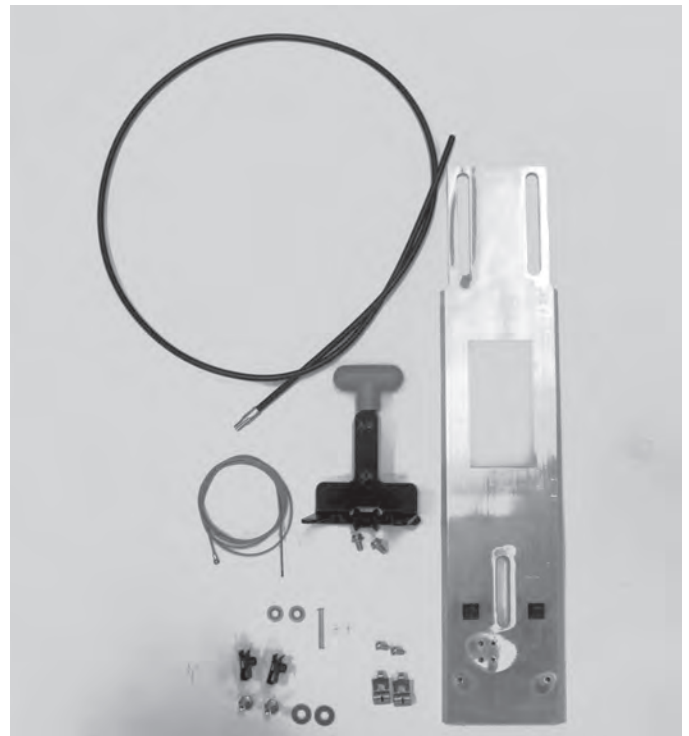
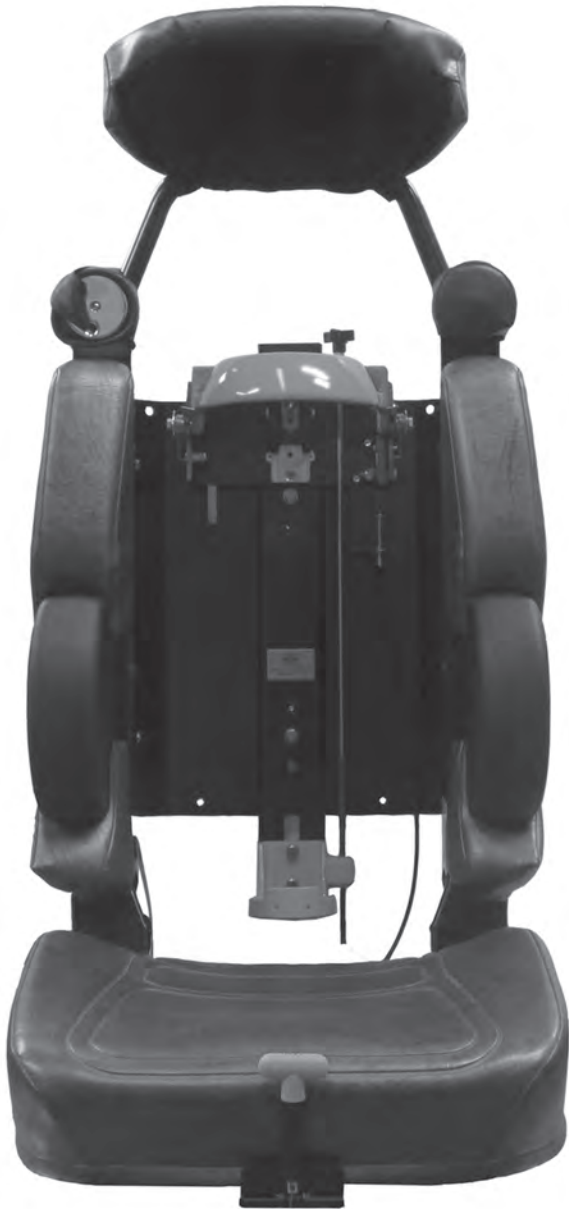

Model QM-EZL-CPR-TS is made for the EZ-LOC SCBA bracket mounted in a Bostrom Tanker Series seat. For additional models and other bracket/seat combinations please contact us at 1-800-711-FIRE.

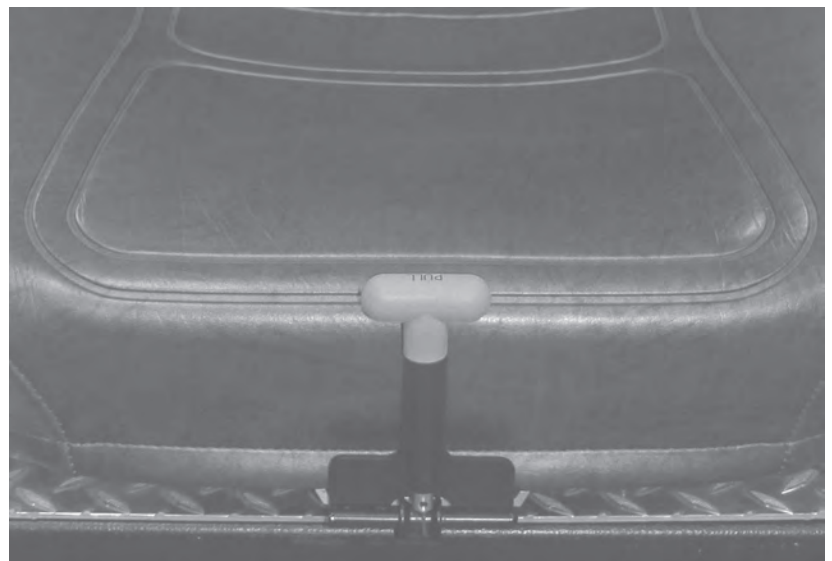

FOOT ADJUSTMENT
OPTIONAL

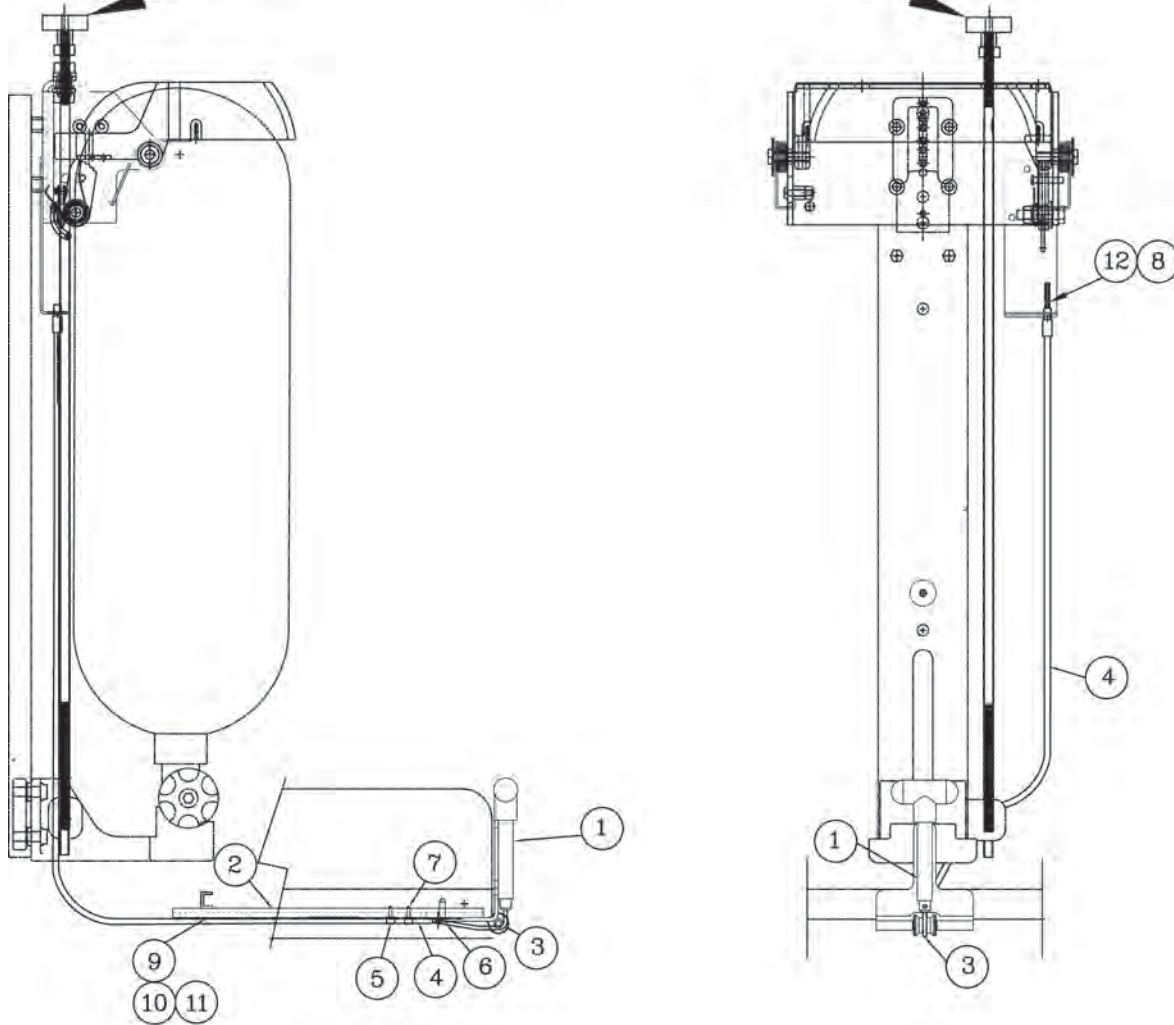

ITEM NO.	PART NO.	DESCRIPTION	QTY.
1	1010-065-905	CENTER PULL RELEASE ASSEMBLY	1
2	1027-144-995	CABLE PLATE ASSEMBLY	1
3	1026-210-101	PULL RELEASE CABLE ASSEMBLY 51.5"	1
4	1026-210-103	CONDUIT 47"	1
5	1027-144-105	CONDUIT CLAMP	2
6	9025-172006	10-32 x 3/8 THRD FRMING, ZPS SCREW	2
7	9010-221606	8-32 x 3/8 PH PHIL	2
8	1026-200-103	SPRING	1
9	9010-102512	1/4-20 x 3/4 HEX SCREW	2
10	9014-112500	1/4-20 FLAT WASHER	2
11	9012-362500	1/4-20 EXT. U NUT	2
12	1027-105-137	PUSH NUT (FOR 6MM ROD)	2

Center Pull Release Installation Instructions for Bostrom 450 Tanker Series Seats

Before installing the Center Pull Release kit, make sure that the EZ-LOC is fully adjusted for the SCBA being used. The EZ-LOC should be mounted in the seat and fully operational.

Important: If you are converting your EZ-LOC from a Universal Pull Release to a Center Pull Release, begin at Step 1. If you are installing the Center Pull Release on a new EZ-LOC with no release, skip to Step 5.

1. Starting with the yellow ball on your Universal Pull Release, push the stop sleeve out of the yellow ball and loosen the set screw. Remove the stop sleeve and yellow ball.

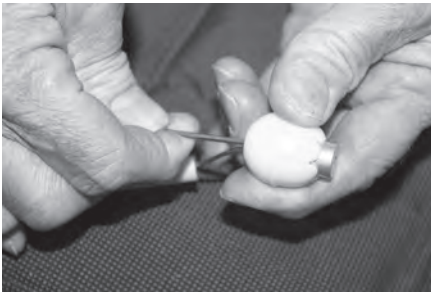

2. Remove the bracket holding the yellow pull release stalk (10" yellow tube) from your seat.

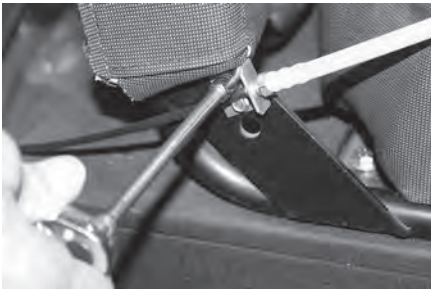

3. Using vise grips and a pry tool, carefully remove the push nut from the black mounting bracket that secures the black conduit assembly.



4. Remove the conduit assembly and slide the cable assembly out through the top of the strap fork. The spring should now be loose.

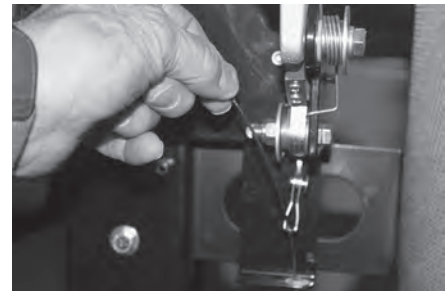

5. Remove the (2) bolts holding the rear of the seat cushion down to the cross brace, then flip the cushion up.
6. Lay out and drill (2) 25/64" holes 2-1/4" apart from the center of the rear seat mount.

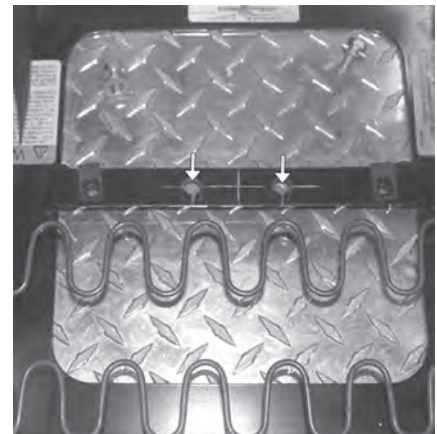

Center Pull Release Installation Instructions Continued

7. Insert the (2) U nuts (*Item 11*) into the holes, threads down.



8. Mount the conduit clamps (*Item 5*) to the flat side of the cable plate (*Item 2*) with the 8-32 x 3/8" screws (*Item 7*). At this time, only hand tighten two full turns.



9. From the channel side of the Cable Plate, pass the non-crimped end of the conduit through the center slot and under the clamps. Push the conduit even with the end of the Cable Plate and tighten the clamps.

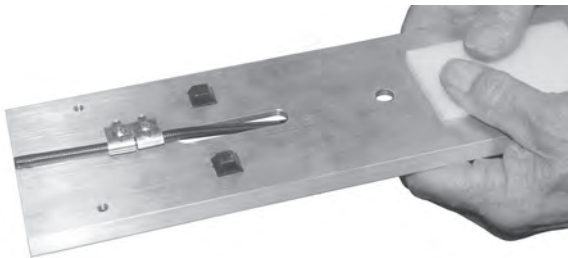

10. Mount the center pull release assembly (*Item 1*) to the channel side of the cable plate with (2) 10-32 x 3/8" screws.

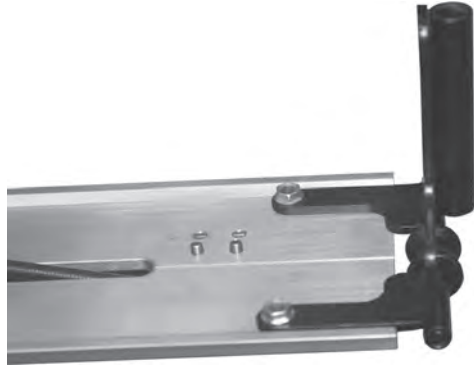

11. Install the conduit and Cable Plate under the front of the seat frame and springs, keeping it above the mounting frame and cross brace.

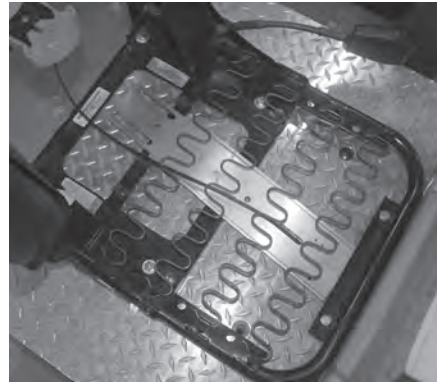

12. Allow the seat cushion to rest back down far enough to start 1/4-20 x 3/4" hex screws with 1/4-20 flat washers through the slots in the Cable Plate and into the U nuts. (Hand tighten two turns.)

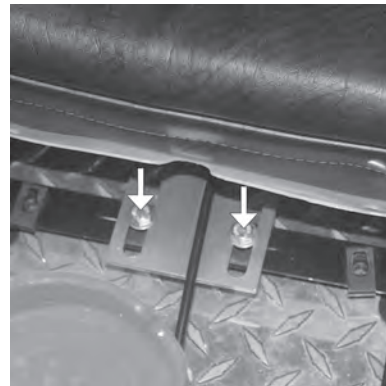

Center Pull Release Installation Instructions Continued

13. Let the seat cushion go all the way down and push the release assembly into the chosen location. Once in place, raise the cushion post enough to tighten the (2) screws holding the cable plate in place.

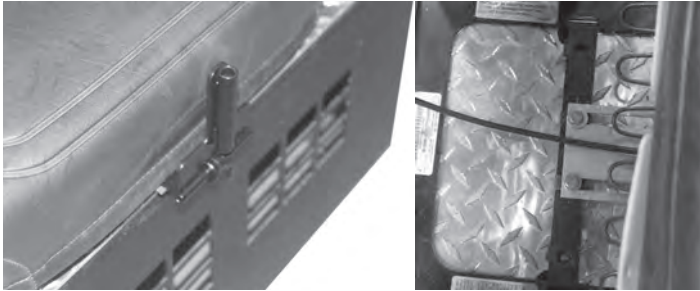

14. Attach your new conduit assembly 47" (Item 4) to the mounting bracket using a 6mm push nut (an extra push nut, Item 12, is provided in the event the first is damaged during installation).

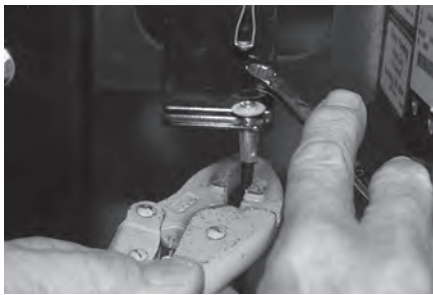

15. Insert your new cable (Item 3) through the strap fork and new spring (Item 8).



16. Slide the cable assembly (Item 3) through the conduit (Item 4). Look for it to extend out from under the roller on the Pull Release Assembly.



17. Feed the cable under the roller and toward the bottom of the "T" handle and pull the Top Clamp on the EZ-LOC down. Check that the Serrated Latch Assembly is fully engaged.

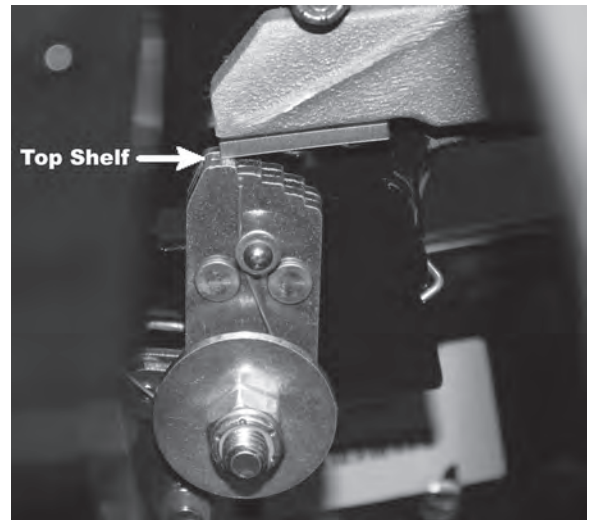

Center Pull Release Installation Instructions Continued

18. Insert the cable into the bottom of the "T" handle shaft. Make sure the "T" handle is in the down position, then tighten the (2) 5/64" hex set screws. (There is one front and one on the back. The handle will need to be rotated 180° to reach the second screw.)

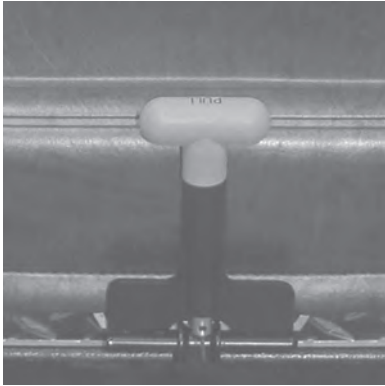

19. The center pull release should now be installed properly. Check to make sure that it releases the EZ-LOC and returns to the locked, fully-engaged position smoothly.
20. Replace the seat cushion and tighten the seat cushion bolts.



Ziamatic Corp.

10 West College Avenue, P.O. Box 337, Yardley, PA 19067-0587 • (215) 493-3618 • FAX: (215) 493-1401

www.ziamatic.com

TOLL FREE: 800-711-3473

*ZICO is a registered trademark for fire, safety and marine products made by Ziamatic Corp.

Copyright Ziamatic Corp. 7-17